

VENICCI®



VENICCI Avionaut AeroFIX

67 cm - 105 cm / max. 17,5 kg

index



2



23



16



19



22

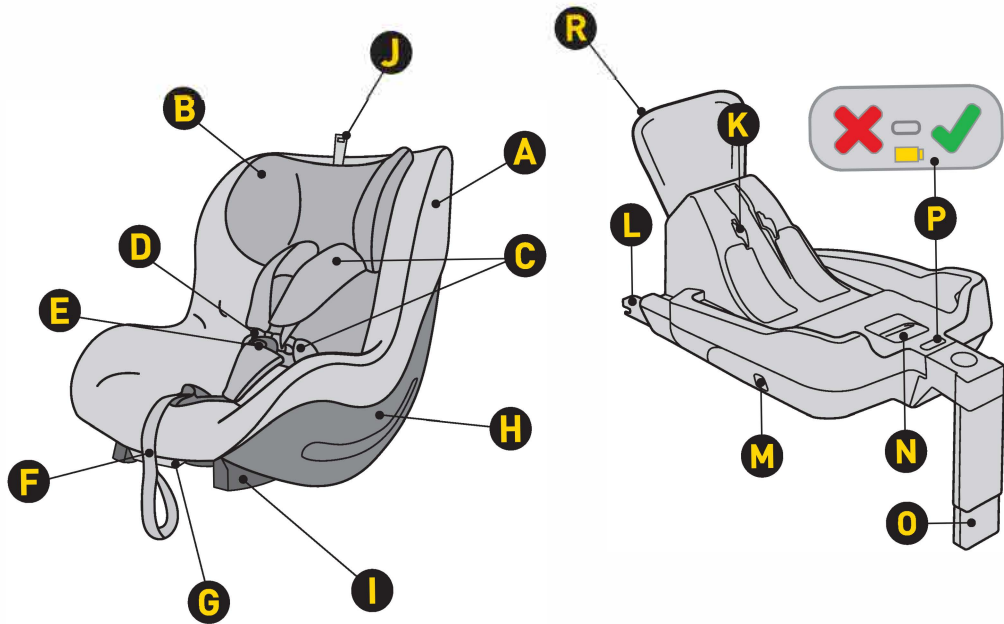

User's manual & Warranty



1

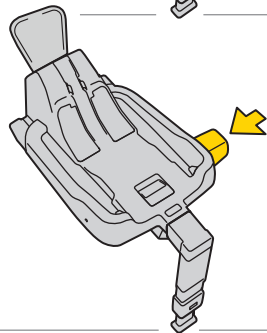
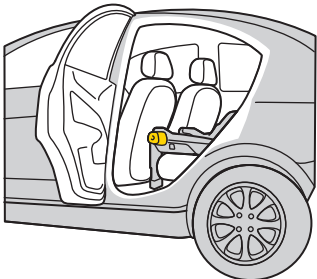
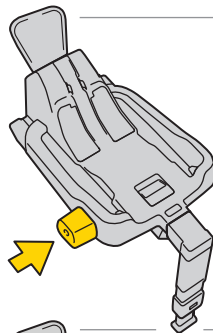
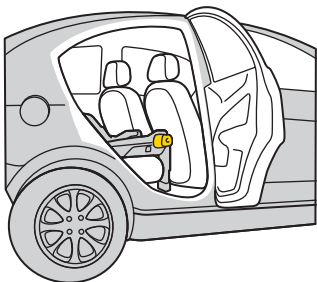

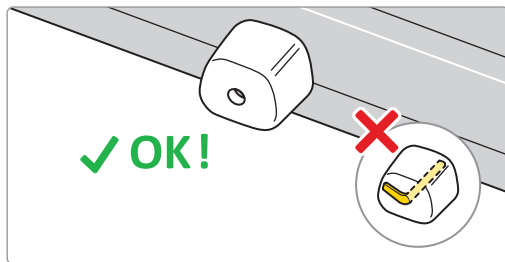
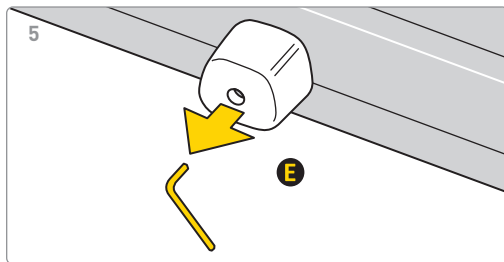
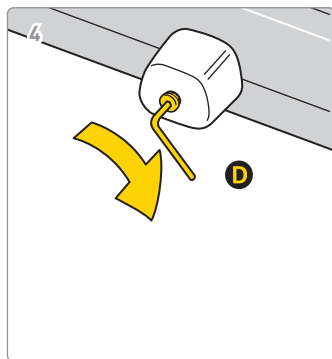
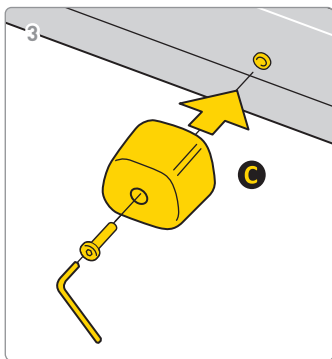
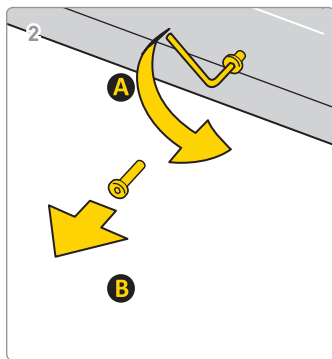



6

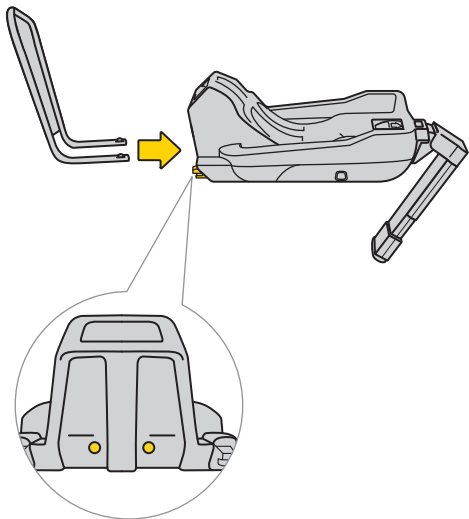

7

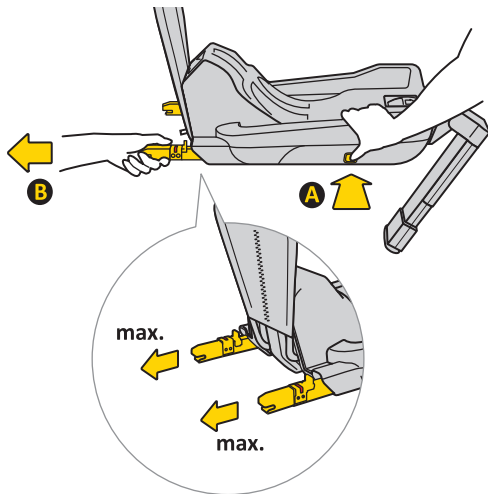

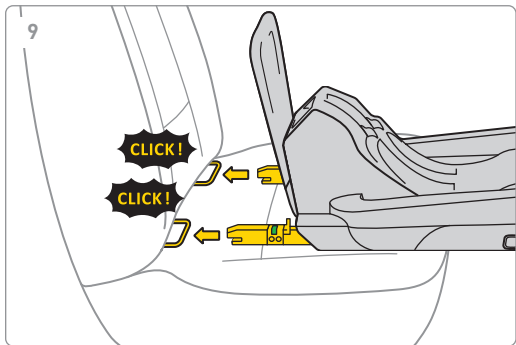
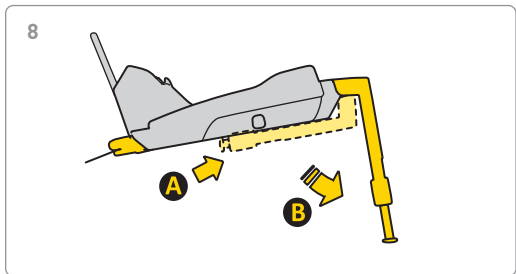



11

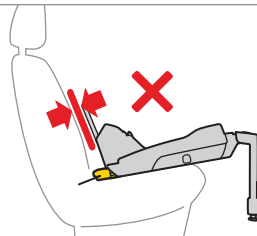
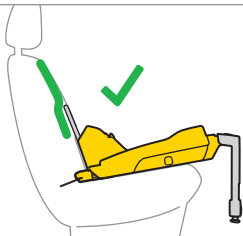
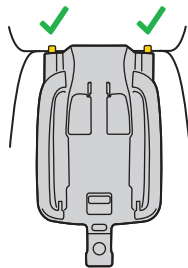
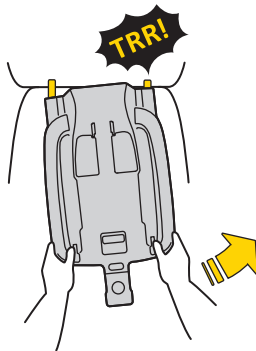
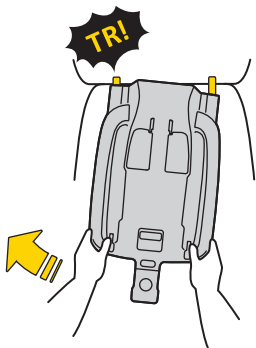



12

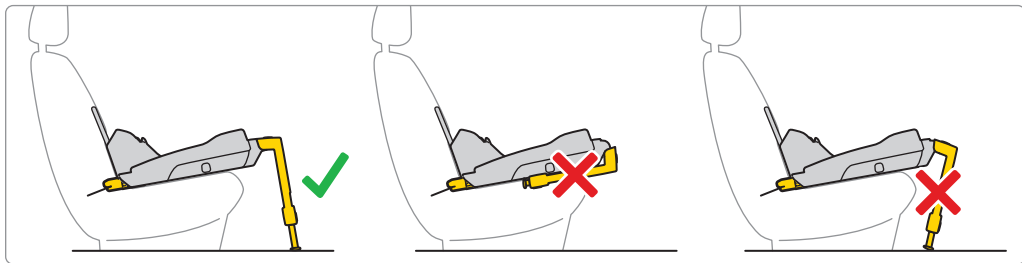
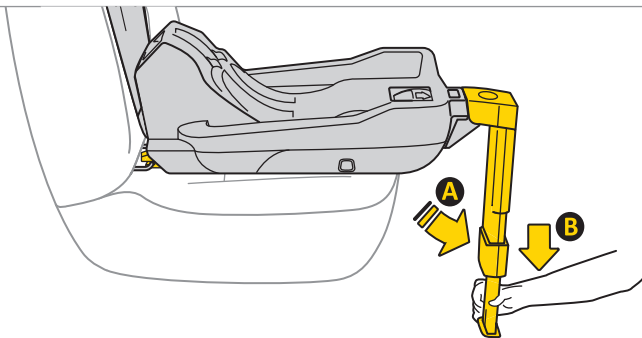

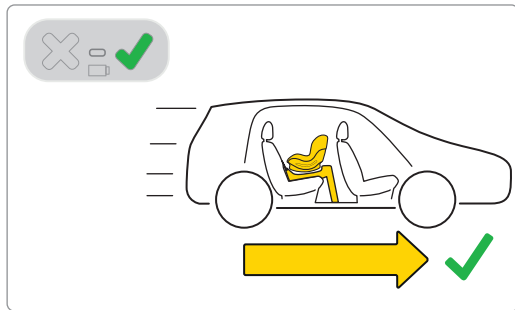
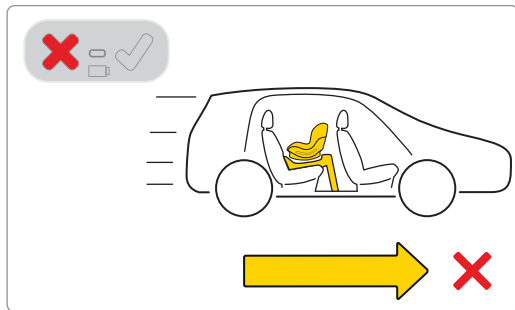
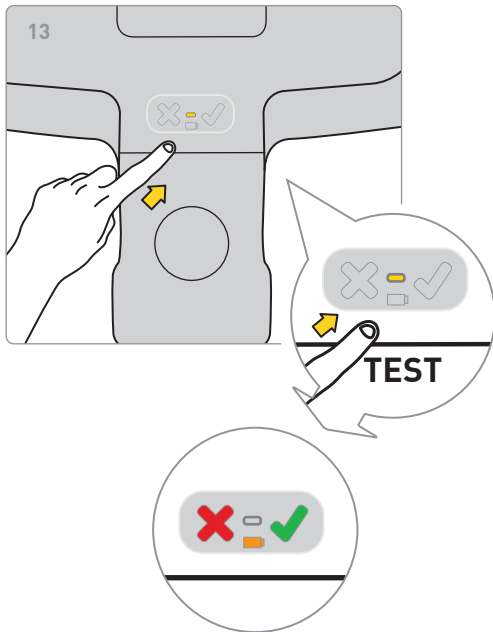



14

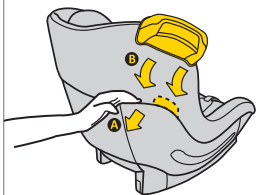

15

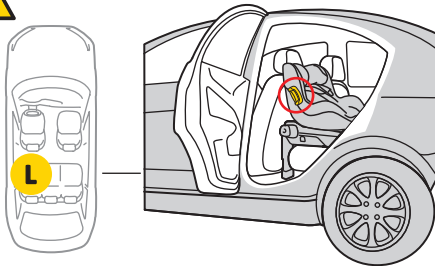
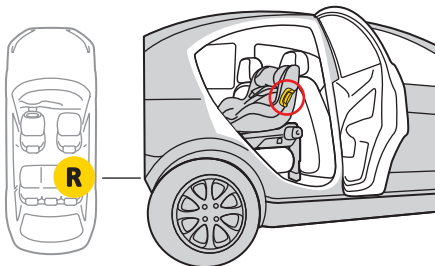

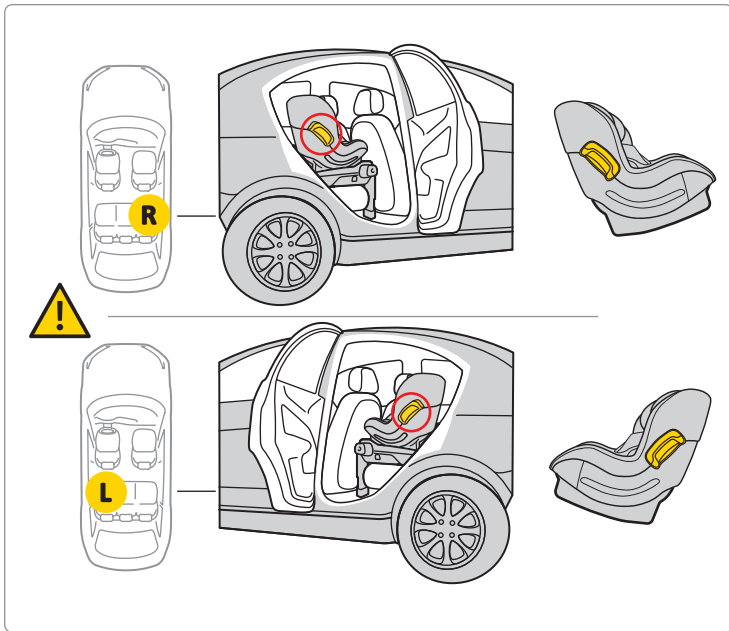
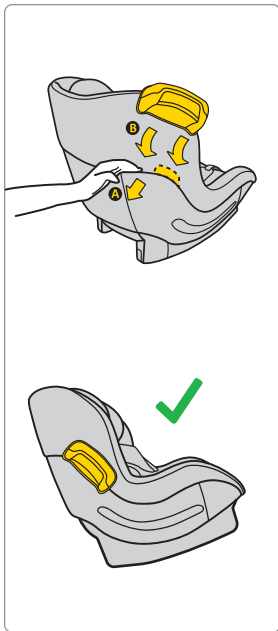



16



67-105 cm
max. 17,5 kg
0M -4Y

🎵 OK!



🎵 NO!



17

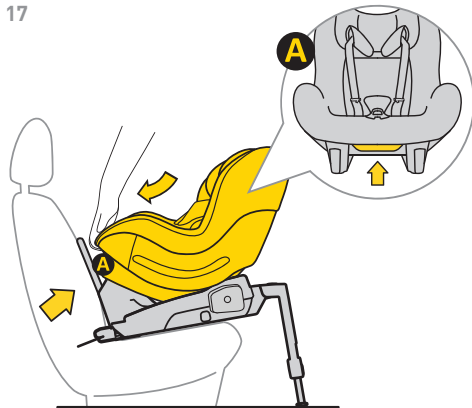

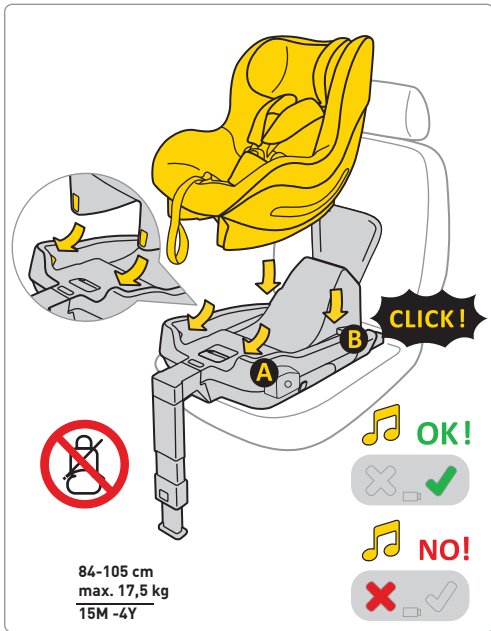



18

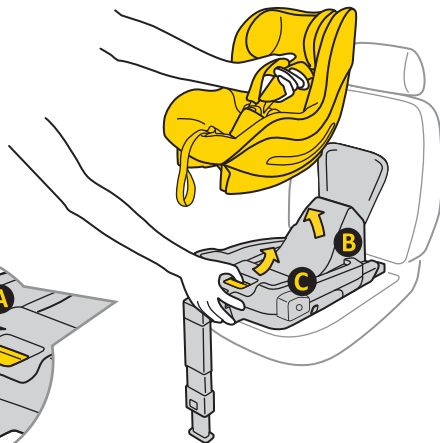
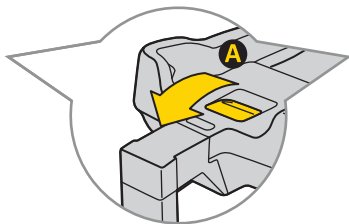



19

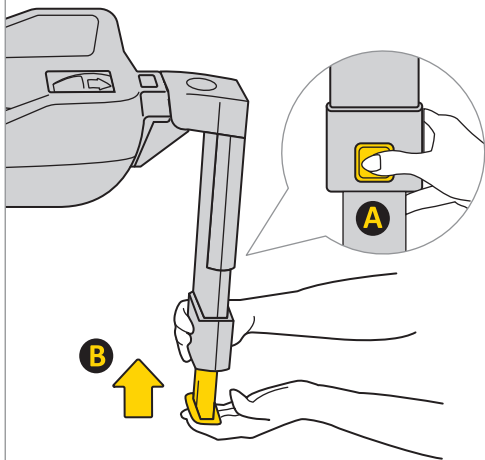

20

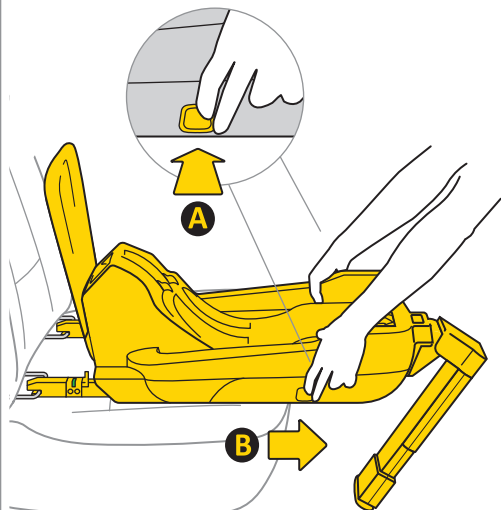

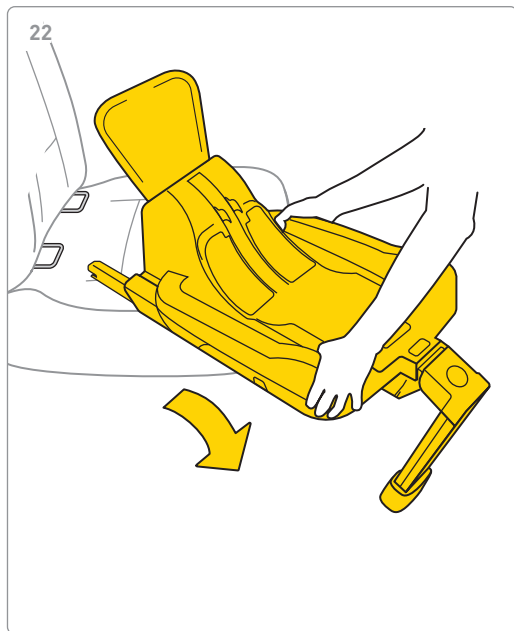
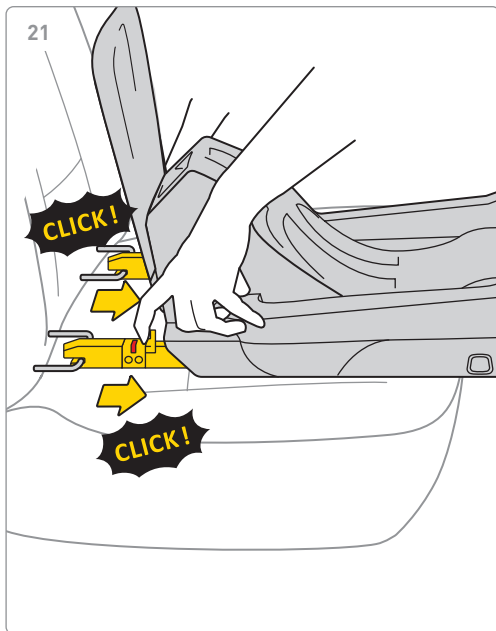

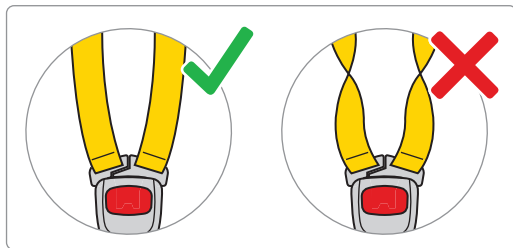
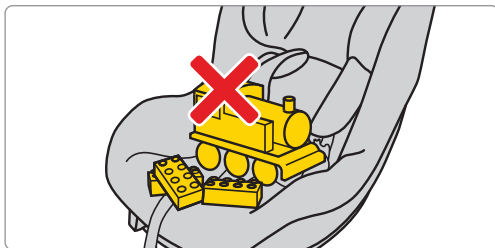
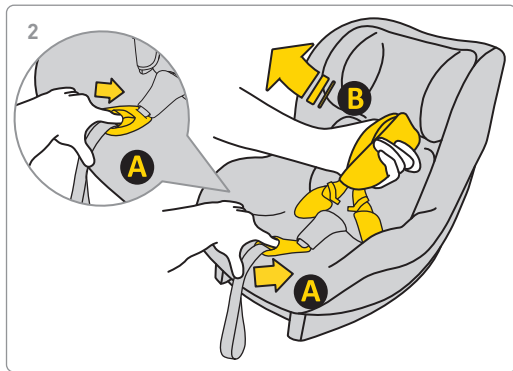
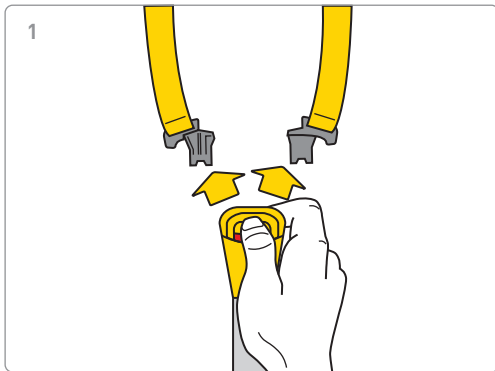



3

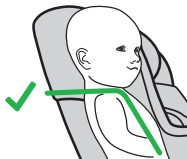
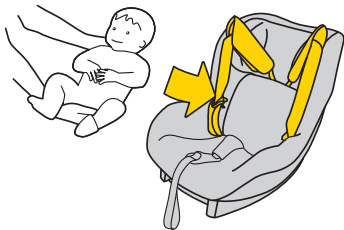

**CORRECT
HARNESS
POSITION**



**INCORRECT
HARNESS
POSITION**

4

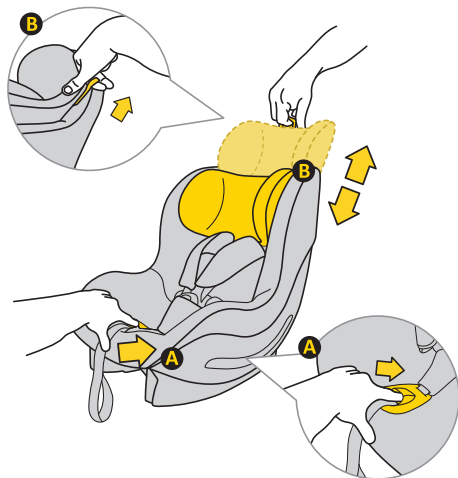



5

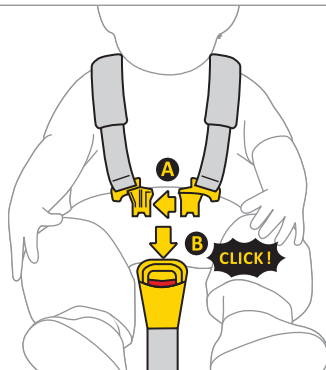

6

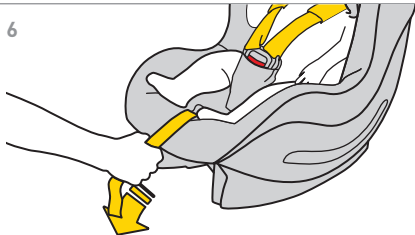

7



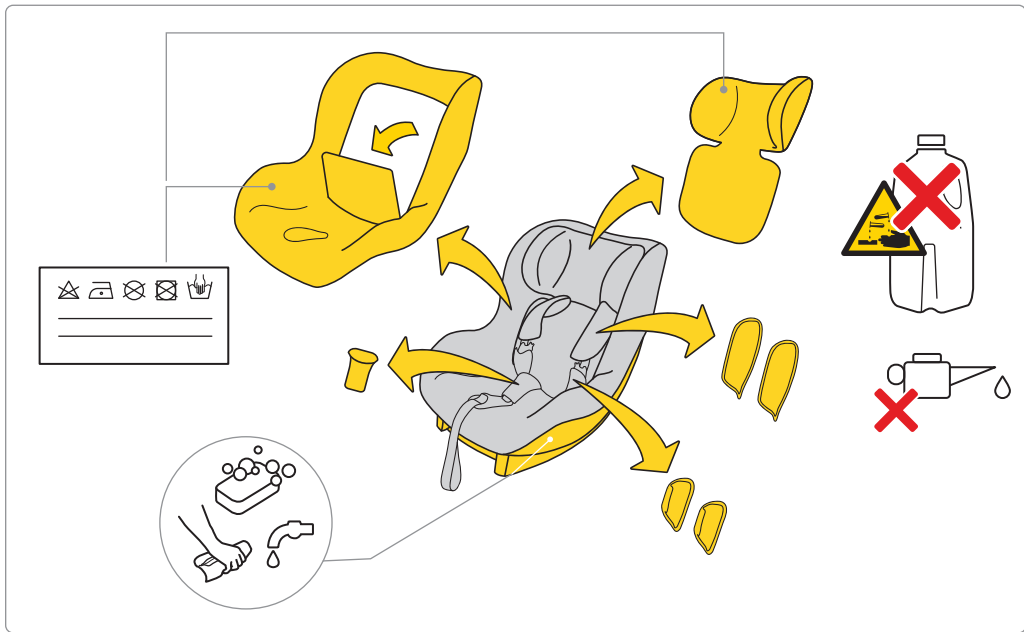

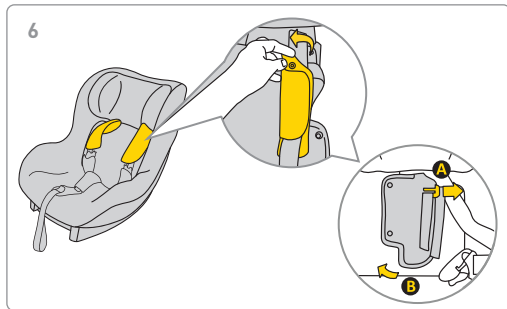
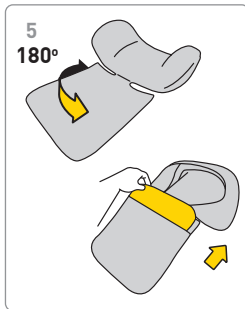
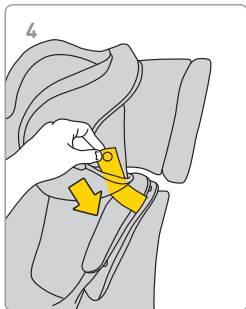
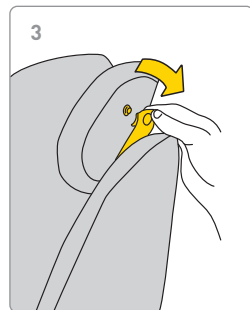
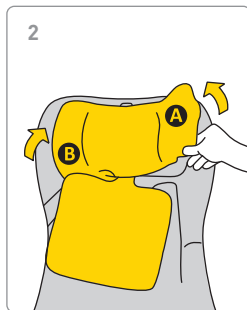
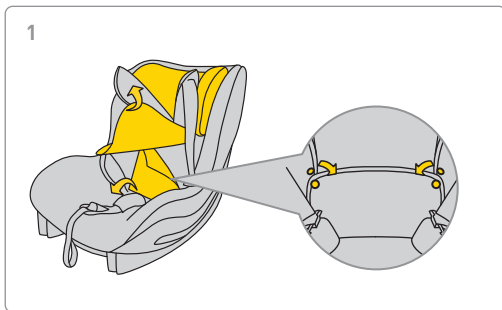

7

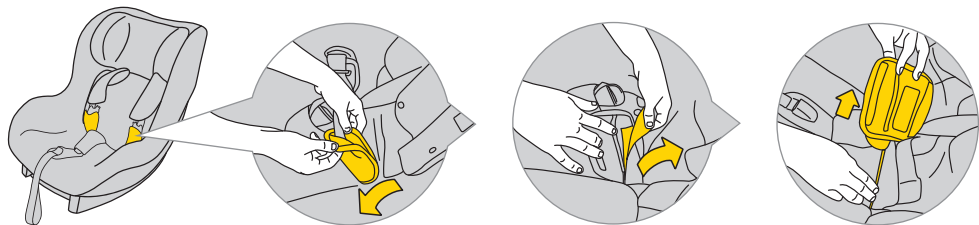

8

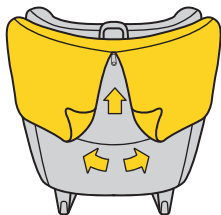

9

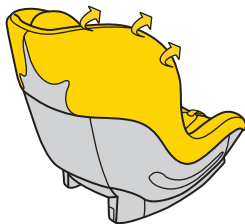

10

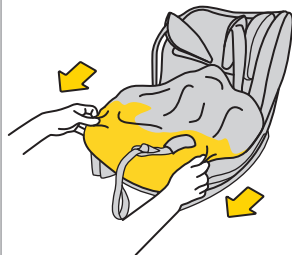

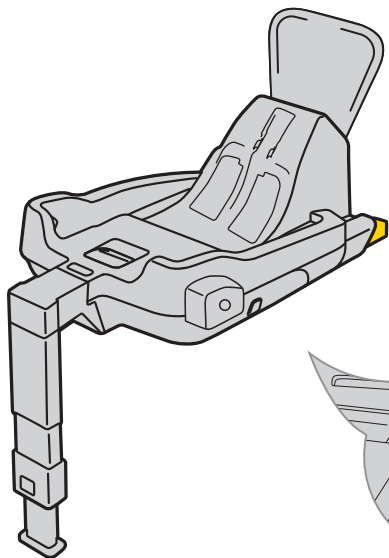

20%

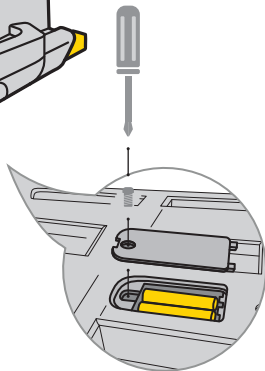

1.5V, AA, LR6



User's manual for the Venicci Avionaut AeroFIX™ child safety seat

Important!

Do not read this manual hastily. Read it carefully, save it for the future and keep it always at hand. If in doubt, please contact us. Please travel safely and treat each car ride seriously. Even when the destination is only a few blocks away.

Warning:

Do not modify the Venicci Avionaut AeroFIX child safety seat in any way, as it may affect the child's safety during its use.

Warning:

Never place the Venicci Avionaut AeroFIX child safety seat on an elevated surface, e.g. on a table or chair.

Warning:

Never install the Venicci Avionaut AeroFIX child safety seat facing backwards to the driving direction on the front passenger seat with an active airbag.

Warning:

If the vehicle has a passenger airbag, move the child safety seat facing forwards to the driving direction as far back as possible.

Attention:

The Venicci Avionaut AeroFIX child safety seat can be installed in the car in both driving directions.

Attention:

It is possible to use the seat facing forwards to the driving direction if your child is less than 15 months old.

- A Upholstery
- B Headrest
- C Belt protectors
- D Harness shoulder belts of the seat
- E Harness belt lock
- F Belt for adjusting the length of the harness belts
- G Lever adjusting the seat inclination angle

- H Seat shell
- I Base mount / base mount
- J Headrest height adjustment
- K Mechanisms for attaching the seat
- L ISOFIX base attachment catch
- M Button to pull out the ISOFIX connector
- N Child safety seat release lever
- O Adjustable leg
- P Control panel
- R Anti-rotation frame

Safety, use and travel

- Before purchase, each child safety seat should be installed in the car to check whether it can be properly installed and used in a given car. Matching the child safety seat model to the car type is one of the most important safety criteria. The seller's assistance during the first installation also guarantees that the installation will be fully correct.
 - Remember that parents are always responsible for the safety of the child while driving.
 - Never leave the child in the safety seat unattended in the car or outside it.
 - Never hold your child on your lap while the car is in motion.
 - The safest place for your child while travelling is the back seat of the car.
 - Before each trip, make sure that the seat belts are not damaged or twisted.
 - When the child safety seat is installed, the rear seat backrest must be locked and cannot move.
 - Before each trip, make sure that the Venicci Avionaut AeroFIX child safety seat has not been pinched in the door or exposed to the movement of luggage or the seat backrest.
 - Make sure all luggage in the car is securely attached.
 - Do not use the Venicci Avionaut AeroFIX child safety seat without upholstery, as it is part of the child safety system.
 - Take short breaks during longer trips. Your child also needs movement.
 - Always cover the child safety seat when you leave the car parked in a sunny place. The upholstery as well as the metal and plastic parts can get extremely hot and burn your child.
 - Always secure the child in the safety seat by fastening the child with the harness belts, also when using the safety seat outside the car.
-

- Make sure that the harness belts are properly fastened so that the child is correctly positioned in the seat.
 - We do not recommend buying used child safety seats – you can never be sure of their history. However, if you decide to buy a used child safety seat, choose one whose use history is known.
 - Do not use the AeroFIX child safety seat for more than 10 years.
 - Replace your child safety seat if it has been involved in an accident.
 - Do not make any modifications to the child safety seat. They may cause partial or total loss of product safety.
 - The child safety seat must always be secured in the car, even if no child is carried in it.
 - The manufacturer takes into account the fact that the child safety seat can leave dents in the upholstery of the vehicle seat. This is unavoidable due to the requirement of tight fitting of the safety seat. The manufacturer is not responsible for any damage caused by this.
 - Make sure that the belts are properly fastened so that the child is correctly positioned in the seat.
 - Harness belts holding the child cannot be used without covers.
 - A bumper is attached to the AeroFIX child safety seat, which should be placed on the side in the designated place.
 - Use the Venicci Avionaut AeroFIX child safety seat only with the IQ base.
 - The Venicci Avionaut AeroFIX child safety seat can be turned in both driving directions.
 - Use the Venicci Avionaut AeroFIX child safety seat when your child is between 67 cm and 105 cm tall and weighs up to 17.5 kg.
 - The child can be facing forwards to the driving direction if the child is at least 15 months old. However, we recommend that the child be transported with the back to the driving direction as long as possible.
 - Test the correct installation of the child safety seat. If one of the LEDs lights up red, correct the seat installation and perform the test again. Do this until the green LED lights up.
 - Make sure that you can place a maximum of one finger between the harness and the child (1cm). If this distance is greater, tighten the harness.
 - Check if the headrest is set to the correct height.
-

- When the child safety seat is facing backwards to the driving direction, it must be set in a lying position.
- The Venicci Avionaut AeroFIX child safety seat is not intended for home use. Use it only in a car.
- We recommend regularly checking that the elements made of expanded polystyrene (EPS) and energy-absorbing materials in the headrest (EPP) have not been damaged.

Maintenance and hygiene

1. The upholstery of the Venicci Avionaut AeroFIX child safety seat can be machine washed at temperatures up to 30°C at speeds up to 600 rpm.
2. Other elements of the safety seat can be washed with soap and a soft sponge.
3. Keep your child safety seat clean. Do not use any moisturising agents or aggressive cleaning agents.
4. Do not use any lubricants, harsh chemicals or moisturisers for moving parts or other parts of the seat.

Environment

- Keep plastic packaging parts out of reach of the child to avoid the risk of suffocation.

- The batteries powering the information panel placed in the base of the child safety seat are subject to proper disposal.
- For reasons of environmental protection, after using the seat, please dispose of it in the appropriate waste management facility, in accordance with applicable local regulations.

Questions

If you have any questions, call your seller or authorised distributor. Prepare the following information:

- The age, height and weight of your child,
- The make and type of the car and the position of the seat on which you will install the Venicci Avionaut AeroFIX child safety in the car.

Warranty

- The Venicci Avionaut AeroFIX child safety seat is covered by a 12-month warranty.
 - We hereby assure you that the product has been manufactured in accordance with current EU requirements regarding safety and quality standards and that at the time of purchase the product is free from manufacturing and material defects.
-

- The warranty is valid in the country of purchase and is satisfied by the authorised distributor.
- The warranty covers all manufacturing defects in regard to the materials and workmanship, provided that the product is used in accordance with the user's manual, under normal conditions, by the first end-user and within 12 months from the date of purchase. Venicci assumes responsibility for the repair or replacement of the defective product, but the guarantor decides about the choice of how to remove the defect and process the complaint.
- The warranty does not cover damage caused by daily use, such as the wear of fabric as well as the natural loss of colours and deterioration of the materials resulting from the normal ageing of the product.
- The warranty also does not apply in the event of damage to the product due to accidental damage, non-observance of the user's manual, improper use, damage due to negligence, fire, contact with liquid or other external causes.
- At the time of filing a complaint, the Venicci Avionaut AeroFIX child safety seat must have all labels or an identification number and may only be serviced by a person authorised to do so.

Do you want to file a complaint?

- Do you want to file a complaint? When you see a defect and want to file a complaint, please contact the seller from whom you purchased the Venicci Avionaut AeroFIX. When making a complaint, you must provide proof of purchase that must be made within 12 months prior to the service request.
 - If it is necessary to send the product to a service centre, you should return the product to the distributor or seller. At the same time, the shipping method and its costs should be agreed on, because in the absence of such agreement, the guarantor may refuse to cover the shipping costs. Damage and/or defects that are not covered by our warranty or consumer rights, and/or damage and/or defects of the product not covered by our warranty may be removed at the agreed fee.
 - Replace your child safety seat with a new one if it has been involved in an accident. To do this, you will need: a note from the police regarding the accident, a photo from an accident with a visible seat or information from the police about this fact, proof of purchase, confirmation from the insurer of not including the child safety seat in the insurance claim, the warranty card and sending the seat, which was involved in the accident to us.
-

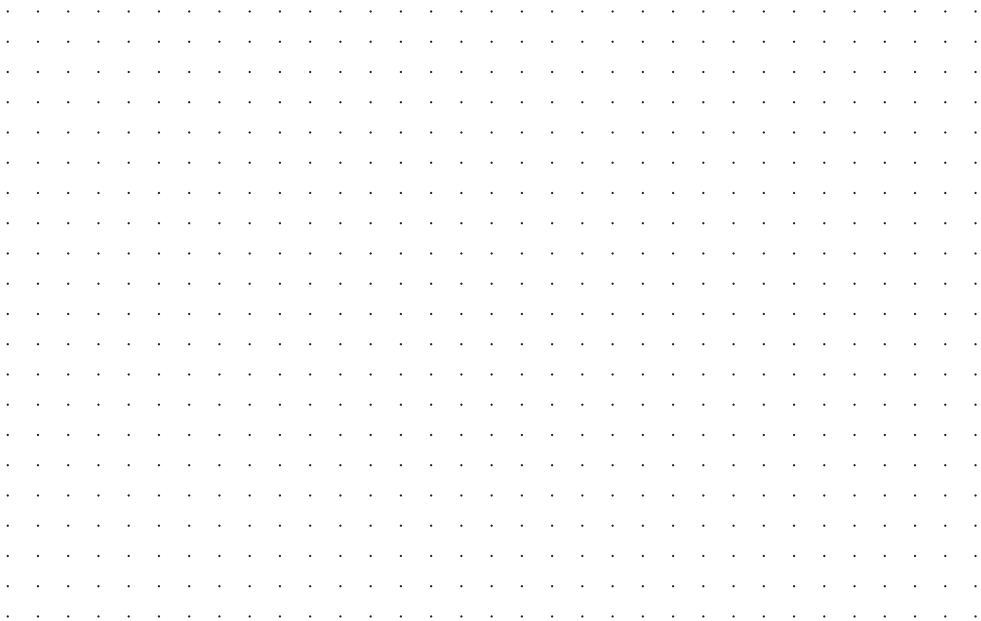

VENICCI®

Venicci UK
MagicBaby LTD
United Kingdom

www.venicci.co.uk
info@venicci.co.uk